

SILVER BOOTH PACKAGES A - C

International Converting Exhibition and Conference

F126741021

Orange County Convention Center (West Building) | Orlando, FL

October 19 - 21, 2021

ONLINE & DISCOUNT DEADLINE:* MONDAY, SEPTEMBER 20, 2021

A Budget and Time Friendly Solution!

Step 1: Select Your Package

Silver Package A - 10' x 10'

CODE	QTY	DISCOUNT	REGULAR	TOTAL
50352A		\$247.80	\$322.35	

Included in this package:

- 8' H Drape (50073)
- (1) 6' x 30" Skirted Table (50046) (choose skirt color in step 2)
- (2) Side Chairs (50020)
- (1) Wastebasket (50091)
- (1)Tuxedo Carpet (10' x 10') (50255)

Silver Package B - 10' x 15'

CODE	QTY	DISCOUNT	REGULAR	TOTAL
50352B		\$303.20	\$394.00	

Included in this package:

- 8' H Drape (50073)
- (1) 6' x 30" Skirted Table (50046) (choose skirt color in step 2)
- (2) Side Chairs (50020)
- (1) Wastebasket (50091)
- (1)Tuxedo Carpet (10' x 15') (5040050)

Silver Package C - 10' x 20'

CODE	QTY	DISCOUNT	REGULAR	TOTAL
50352C		\$468.55	\$609.00	

Included in this package:

- 8' H Drape (50073)
- (1) 6' x 30" Skirted Table (50046) (choose skirt color in step 2)
- (4) Side Chairs (50020)
- (1) Wastebasket (50091)
- (1)Tuxedo Carpet (10' x 20') (50256)



Step 2. Choose your table drape color.

- | | |
|-------------------------------------|--|
| <input type="checkbox"/> Red (01) | <input type="checkbox"/> Burgundy (07) |
| <input type="checkbox"/> Blue (05) | <input type="checkbox"/> Gold (04) |
| <input type="checkbox"/> Black (06) | <input type="checkbox"/> Grey (10) |
| <input type="checkbox"/> Green (02) | <input type="checkbox"/> Teal (13) |
| <input type="checkbox"/> White (03) | |

If a drape color is not chosen, a color will be chosen for you upon order submission.

TOTAL ESTIMATE	\$ _____
TAX (All tax rates are subject to change)	6.50%
AMOUNT DUE	\$ _____

Submission of this form indicates you read and accept the Payment Policy and Terms & Conditions. All orders cancelled by the exhibitor within 30 days of first day of exhibitor move in day may be subject to cancellation fees up to 100% of the total order, based upon the status of move-in, work performed and/or Shepard set-up costs or expenses.

COMPANY NAME: _____ BOOTH NUMBER: _____

CONTACT NAME: _____

CONTACT EMAIL ADDRESS: _____



Email completed form to: customerservice@shepardes.com

SILVER BOOTH PACKAGES D - E

International Converting Exhibition and Conference

F126741021

Orange County Convention Center (West Building) | Orlando, FL

October 19 - 21, 2021

ONLINE & DISCOUNT DEADLINE:* MONDAY, SEPTEMBER 20, 2021

A Budget and Time Friendly Solution!

Step 1: Select Your Package

Silver Package D - 10' x 30'

CODE	QTY	DISCOUNT	REGULAR	TOTAL
50352D		\$578.80	\$752.35	

Included in this package:

- 8' H Drape (50073)
- (2) 6' x 30" Skirted Table (50046) (choose skirt color in step 2)
- (4) Side Chairs (50020)
- (1) Wastebasket (50091)
- (1) Tuxedo Carpet (10' x 30') (50257)



Rendering does not display all items included in packages listed on this page.









Silver Package E - 10' x 40'

CODE	QTY	DISCOUNT	REGULAR	TOTAL
50352E		\$689.10	\$895.65	

Included in this package:

- 8' H Drape (50073)
- (2) 6' x 30" Skirted Table (50046) (choose skirt color in step 2)
- (4) Side Chairs (50020)
- (1) Wastebasket (50091)
- (1) Tuxedo Carpet (10' x 40') (50258)

Step 2. Choose your table drape color.

- | | |
|---|--|
| <input type="checkbox"/>  Red (01) | <input type="checkbox"/>  Burgundy (07) |
| <input type="checkbox"/>  Blue (05) | <input type="checkbox"/>  Gold (04) |
| <input type="checkbox"/>  Black (06) | <input type="checkbox"/>  Grey (10) |
| <input type="checkbox"/>  Green (02) | <input type="checkbox"/>  Teal (13) |
| <input type="checkbox"/>  White (03) | |

If a drape color is not chosen, a color will be chosen for you upon order submission.

TOTAL ESTIMATE	\$ _____
TAX (All tax rates are subject to change)	6.50%
AMOUNT DUE	\$ _____

Submission of this form indicates you read and accept the Payment Policy and Terms & Conditions. All orders cancelled by the exhibitor within 30 days of first day of exhibitor move in day may be subject to cancellation fees up to 100% of the total order, based upon the status of move-in, work performed and/or Shepard set-up costs or expenses.

COMPANY NAME: _____ BOOTH NUMBER: _____

CONTACT NAME: _____

CONTACT EMAIL ADDRESS: _____



Email completed form to: customerservice@shepardes.com

10' X 10' ALL-INCLUSIVE PACKAGES

International Converting Exhibition and Conference

F126741021

Orange County Convention Center (West Building) | Orlando, FL

October 19 - 21, 2021

ONLINE & DISCOUNT DEADLINE:* MONDAY, SEPTEMBER 20, 2021

10' x 10' Gold Booth Package

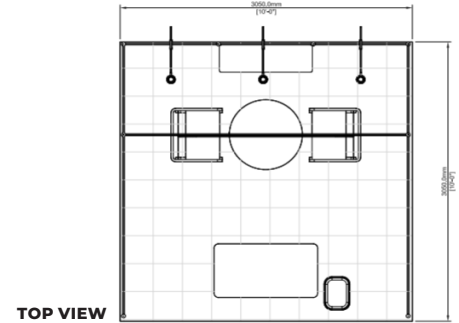
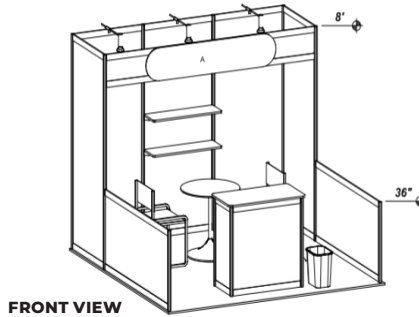

Gold Package - 10' x 10'

CODE	QTY	DISCOUNT	REGULAR	TOTAL
66380		\$1,460.80	\$2,191.25	

Included in this package:

- (1) Tuxedo Carpet (10' x 10') (50255)
- (1) 500 Watt Outlet
- Company Name Fascia Sign(s) (14" x 72")
- (1) Round Pedestal Table - 36" dia x 30" high (50032)
- (1) Lockable Counter (1m x 1m x .5m) (66282)
- (2) Shelves Mounted on Backwall (12" x 39") (66053)
- Nightly Vacuuming & waste removal (47002/47031)
- (2) Side Chairs (50020)
- (1) Wastebasket (50091)
- (3) Stem Lights (66051)

Text for booth header:

For any modifications or changes to the All-Inclusive Booth Packages please contact our Exhibit Solutions Department at exhibits@shepardes.com

TOTAL ESTIMATE	\$ _____
TAX (All tax rates are subject to change)	6.50%
AMOUNT DUE	\$ _____

Submission of this form indicates you read and accept the Payment Policy and Terms & Conditions. All orders cancelled by the exhibitor within 30 days of first day of exhibitor move in day may be subject to cancellation fees up to 100% of the total order, based upon the status of move-in, work performed and/or Shepard set-up costs or expenses. There are no exchanges or refunds once item has been delivered to your booth. Cancellations must be received in writing within 14 days prior to first exhibitor move in day.

Rental items found and in use in your booth are subject to "Standard" pricing.

COMPANY NAME: _____ BOOTH NUMBER: _____

CONTACT NAME: _____

CONTACT EMAIL ADDRESS: _____

Email completed form to: customerservice@shepardes.com



10' X 15' ALL-INCLUSIVE PACKAGES

International Converting Exhibition and Conference

F126741021

Orange County Convention Center (West Building) | Orlando, FL

October 19 - 21, 2021

ONLINE & DISCOUNT DEADLINE:* MONDAY, SEPTEMBER 20, 2021

10' x 15' Gold Booth Package

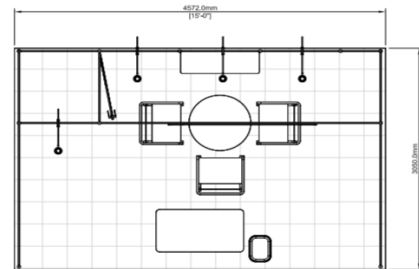
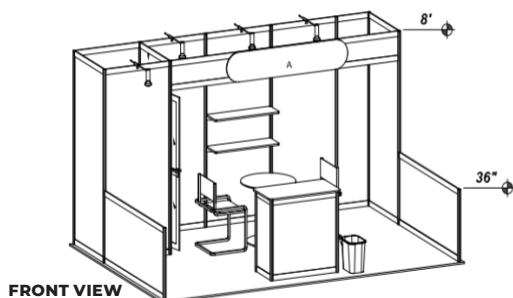

Gold Package - 10' x 15'

CODE	QTY	DISCOUNT	REGULAR	TOTAL
66381		\$1,681.30	\$2,522.00	

Included in this package:

- (1) Tuxedo Carpet (10' x 15') (50400)
- (1) 500 Watt Outlet
- Company Name Fascia Sign(s) (14" x 72")
- (1) Round Pedestal Table - 36" dia x 30" high (50032)
- (1) Lockable Counter (1m x 1m x .5m) (66282)
- (2) Shelves Mounted on Backwall (12" x 39") (66053)
- 1m x 1m Closet
- Nightly Vacuuming & waste removal (47002/47031)
- (3) Side Chairs (50020)
- (1) Wastebasket (50091)
- (4) Stem Lights (66051)

Text for booth header:

For any modifications or changes to the All-Inclusive Booth Packages please contact our Exhibit Solutions Department at exhibits@shepardes.com

TOTAL ESTIMATE	\$ _____
TAX (All tax rates are subject to change)	6.50%
AMOUNT DUE	\$ _____

Submission of this form indicates you read and accept the Payment Policy and Terms & Conditions. All orders cancelled by the exhibitor within 30 days of first day of exhibitor move in day may be subject to cancellation fees up to 100% of the total order, based upon the status of move-in, work performed and/or Shepard set-up costs or expenses. There are no exchanges or refunds once item has been delivered to your booth. Cancellations must be received in writing within 14 days prior to first exhibitor move in day.

Rental items found and in use in your booth are subject to "Standard" pricing.

COMPANY NAME: _____ BOOTH NUMBER: _____

CONTACT NAME: _____

CONTACT EMAIL ADDRESS: _____



Email completed form to: customerservice@shepardes.com

10' X 20' ALL-INCLUSIVE PACKAGES

International Converting Exhibition and Conference

F126741021

Orange County Convention Center (West Building) | Orlando, FL

October 19 - 21, 2021

ONLINE & DISCOUNT DEADLINE:* MONDAY, SEPTEMBER 20, 2021

10' x 20' Gold Booth Package

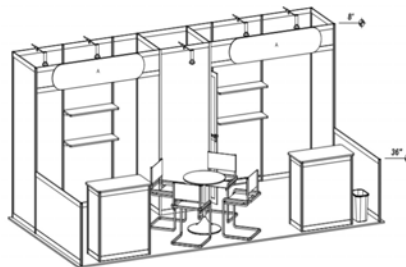

FRONT VIEW

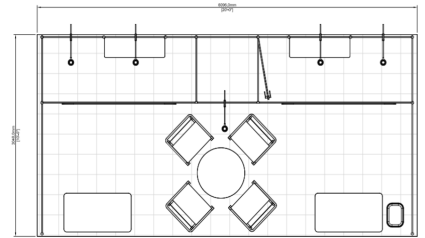

TOP VIEW

Gold Package - 10' x 20'

CODE	QTY	DISCOUNT	REGULAR	TOTAL
66382		\$2,921.60	\$4,382.45	

Included in this package:

- (1) Tuxedo Carpet (10' x 20') (50256)
- (1) 500 Watt Outlet
- Company Name Fascia Sign(s) (14" x 72")
- (1) Round Pedestal Table - 36" dia x 30" high (50032)
- (2) Lockable Counter (1m x 1m x .5m) (66282)
- (4) Shelves Mounted on Backwall (12" x 39") (66053)
- 1m x 1m Closet
- Nightly Vacuuming & waste removal (47002/47031)
- (4) Side Chairs (50020)
- (1) Wastebasket (50091)
- (5) Stem Lights (66051)

Text for booth header:

For any modifications or changes to the All-Inclusive Booth Packages please contact our Exhibit Solutions Department at exhibits@shepardes.com

TOTAL ESTIMATE	\$ _____
TAX (All tax rates are subject to change)	6.50%
AMOUNT DUE	\$ _____

Submission of this form indicates you read and accept the Payment Policy and Terms & Conditions. All orders cancelled by the exhibitor within 30 days of first day of exhibitor move in day may be subject to cancellation fees up to 100% of the total order, based upon the status of move-in, work performed and/or Shepard set-up costs or expenses. There are no exchanges or refunds once item has been delivered to your booth. Cancellations must be received in writing within 14 days prior to first exhibitor move in day.

Rental items found and in use in your booth are subject to "Standard" pricing.

COMPANY NAME: _____ BOOTH NUMBER: _____

CONTACT NAME: _____

CONTACT EMAIL ADDRESS: _____

Email completed form to: customerservice@shepardes.com



10' X 30' ALL-INCLUSIVE PACKAGES

International Converting Exhibition and Conference

F126741021

Orange County Convention Center (West Building) | Orlando, FL

October 19 - 21, 2021

ONLINE & DISCOUNT DEADLINE:* MONDAY, SEPTEMBER 20, 2021

10' x 30' Gold Booth Package

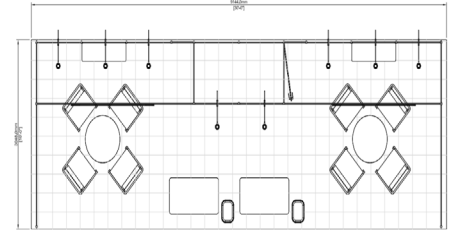
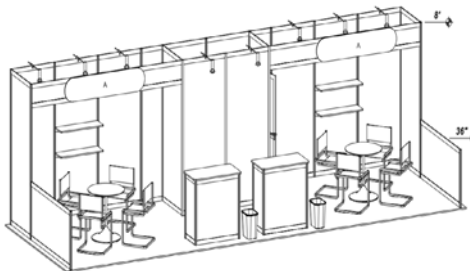

FRONT VIEW

TOP VIEW

Gold Package - 10' x 30'

CODE	QTY	DISCOUNT	REGULAR	TOTAL
66383		\$4,024.15	\$6,036.20	

Included in this package:

- (1) Tuxedo Carpet (10' x 30') (50257)
- (1) 500 Watt Outlet
- Company Name Fascia Sign(s) (14" x 72")
- (2) Round Pedestal Table - 36" dia x 30" high (50032)
- (2) Lockable Counter (1m x 1m x .5m) (66282)
- (4) Shelves Mounted on Backwall (12" x 39") (66053)
- 1m x 2m Closet
- Nightly Vacuuming & waste removal (47002/47031)
- (8) Side Chairs (50020)
- (2) Wastebasket (50091)
- (8) Stem Lights (66051)

Text for booth header:

For any modifications or changes to the All-Inclusive Booth Packages please contact our Exhibit Solutions Department at exhibits@shepardes.com

TOTAL ESTIMATE	\$ _____
TAX (All tax rates are subject to change)	6.50%
AMOUNT DUE	\$ _____

Submission of this form indicates you read and accept the Payment Policy and Terms & Conditions. All orders cancelled by the exhibitor within 30 days of first day of exhibitor move in day may be subject to cancellation fees up to 100% of the total order, based upon the status of move-in, work performed and/or Shepard set-up costs or expenses. There are no exchanges or refunds once item has been delivered to your booth. Cancellations must be received in writing within 14 days prior to first exhibitor move in day.

Rental items found and in use in your booth are subject to "Standard" pricing.

COMPANY NAME: _____ BOOTH NUMBER: _____

CONTACT NAME: _____

CONTACT EMAIL ADDRESS: _____



Email completed form to: customerservice@shepardes.com

15' X 20' ALL-INCLUSIVE PACKAGES

International Converting Exhibition and Conference

F126741021

Orange County Convention Center (West Building) | Orlando, FL

October 19 - 21, 2021

ONLINE & DISCOUNT DEADLINE:* MONDAY, SEPTEMBER 20, 2021

15' x 20' Gold Booth Package

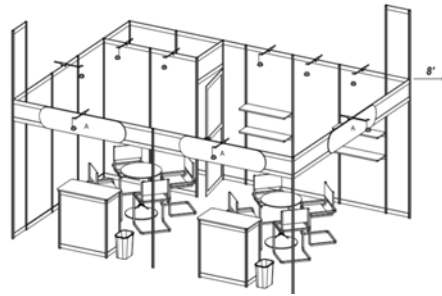
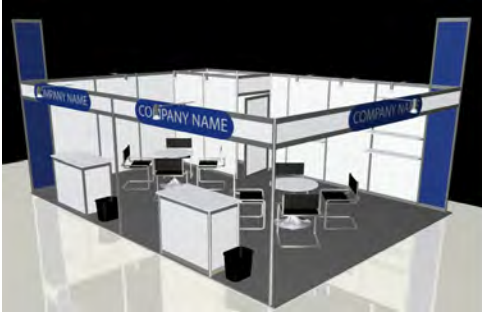

FRONT VIEW

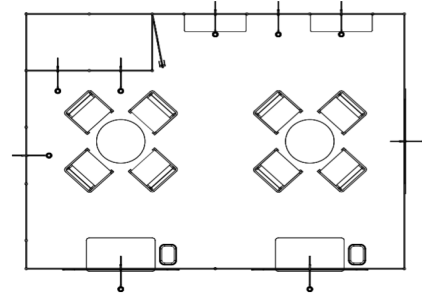

TOP VIEW

Gold Package - 15' x 20'

CODE	QTY	DISCOUNT	REGULAR	TOTAL
66385		\$4,024.15	\$6,036.20	

Included in this package:

- (1) Tuxedo Carpet (15' x 20') (50580)
- (1) 500 Watt Outlet
- Company Name Fascia Sign(s) (14" x 72")
- (2) Round Pedestal Table - 36" dia x 30" high (50032)
- (2) Lockable Counter (1m x 1m x .5m) (66282)
- (4) Shelves Mounted on Backwall (12" x 39") (66053)
- 1m x 2m Closet
- Nightly Vacuuming & waste removal (47002/47031)
- (8) Side Chairs (50020)
- (2) Wastebasket (50091)
- (9) Stem Lights (66051)

Text for booth header:

For any modifications or changes to the All-Inclusive Booth Packages please contact our Exhibit Solutions Department at exhibits@shepardes.com

TOTAL ESTIMATE	\$ _____
TAX (All tax rates are subject to change)	6.50%
AMOUNT DUE	\$ _____

Submission of this form indicates you read and accept the Payment Policy and Terms & Conditions. All orders cancelled by the exhibitor within 30 days of first day of exhibitor move in day may be subject to cancellation fees up to 100% of the total order, based upon the status of move-in, work performed and/or Shepard set-up costs or expenses. There are no exchanges or refunds once item has been delivered to your booth. Cancellations must be received in writing within 14 days prior to first exhibitor move in day.

Rental items found and in use in your booth are subject to "Standard" pricing.

COMPANY NAME: _____ BOOTH NUMBER: _____

CONTACT NAME: _____

CONTACT EMAIL ADDRESS: _____

Email completed form to: customerservice@shepardes.com



20' X 20' ALL-INCLUSIVE PACKAGES

International Converting Exhibition and Conference

F126741021

Orange County Convention Center (West Building) | Orlando, FL

October 19 - 21, 2021

ONLINE & DISCOUNT DEADLINE:* MONDAY, SEPTEMBER 20, 2021

20' x 20' Gold Booth Package

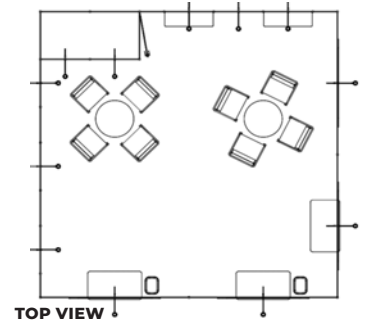
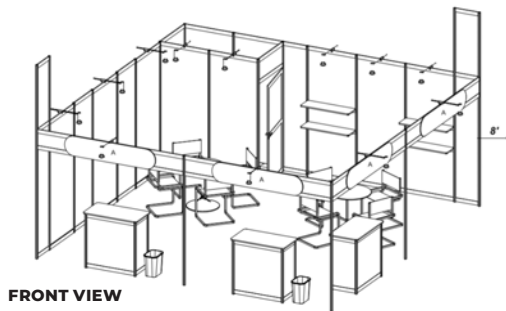

Gold Package - 20' x 20'

CODE	QTY	DISCOUNT	REGULAR	TOTAL
66386		\$5,347.15	\$7,993.15	

Please Note: The layout of your booth will be determined by your booth's position on the show floor.
**** The 20' x 30' booths are Split Island Booths. ****

Included in this package:

- (1) Tuxedo Carpet (20' x 30') (50259)
- (1) 500 Watt Outlet
- Company Name Fascia Sign(s) (14" x 72")
- (2) Round Pedestal Table - 36" dia x 30" high (50032)
- (3) Lockable Counter (1m x 1m x .5m) (66282)
- (4) Shelves Mounted on Backwall (12" x 39") (66053)
- 1m x 2m Closet
- Nightly Vacuuming & waste removal (47002/47031)
- (8) Side Chairs (50020)
- (2) Wastebasket (50091)
- (12) Stem Lights (66051)

Text for booth header:

For any modifications or changes to the All-Inclusive Booth Packages please contact our Exhibit Solution Department at exhibits@shepardes.com

TOTAL ESTIMATE	\$ _____
TAX (All tax rates are subject to change)	6.50%
AMOUNT DUE	\$ _____

Submission of this form indicates you read and accept the Payment Policy and Terms & Conditions. All orders cancelled by the exhibitor within 30 days of first day of exhibitor move in day may be subject to cancellation fees up to 100% of the total order, based upon the status of move-in, work performed and/or Shepard set-up costs or expenses. There are no exchanges or refunds once item has been delivered to your booth. Cancellations must be received in writing within 14 days prior to first exhibitor move in day.

Rental items found and in use in your booth are subject to "Standard" pricing.

COMPANY NAME: _____ BOOTH NUMBER: _____

CONTACT NAME: _____

CONTACT EMAIL ADDRESS: _____



Email completed form to: customerservice@shepardes.com

20' X 30' ALL-INCLUSIVE PACKAGES

International Converting Exhibition and Conference

F126741021

Orange County Convention Center (West Building) | Orlando, FL

October 19 - 21, 2021

ONLINE & DISCOUNT DEADLINE:* MONDAY, SEPTEMBER 20, 2021

20' x 30' Gold Booth Package

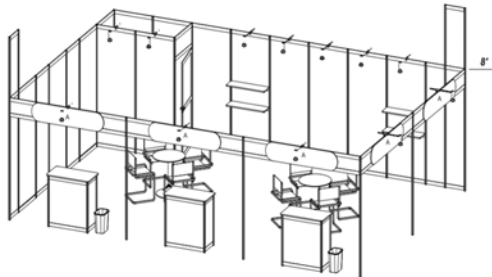

FRONT VIEW

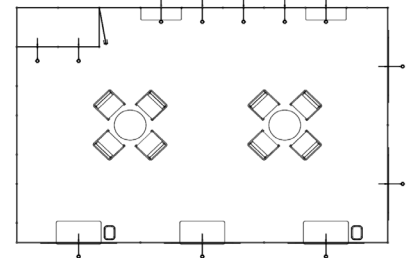

TOP VIEW

Gold Package - 20' x 30'

CODE	QTY	DISCOUNT	REGULAR	TOTAL
66387		\$6,008.65	\$9,012.95	

**Please Note: The layout of your booth will be determined by your booth's position on the show floor.
** The 20' x 30' booths are Split Island Booths. ****

Included in this package:

- (1) Tuxedo Carpet (20' x 30') (50259)
- (1) 500 Watt Outlet
- Company Name Fascia Sign(s) (14" x 72")
- (2) Round Pedestal Table - 36" dia x 30" high (50032)
- (3) Lockable Counter (1m x 1m x .5m) (66282)
- (4) Shelves Mounted on Backwall (12" x 39") (66053)
- 1m x 2m Closet
- Nightly Vacuuming & waste removal (47002/47031)
- (8) Side Chairs (50020)
- (2) Wastebasket (50091)
- (12) Stem Lights (66051)

Text for booth header:

For any modifications or changes to the All-Inclusive Booth Packages please contact our Exhibit Solution Department at exhibits@shepardes.com

TOTAL ESTIMATE	\$ _____
TAX (All tax rates are subject to change)	6.50%
AMOUNT DUE	\$ _____

Submission of this form indicates you read and accept the Payment Policy and Terms & Conditions. All orders cancelled by the exhibitor within 30 days of first day of exhibitor move in day may be subject to cancellation fees up to 100% of the total order, based upon the status of move-in, work performed and/or Shepard set-up costs or expenses. There are no exchanges or refunds once item has been delivered to your booth. Cancellations must be received in writing within 14 days prior to first exhibitor move in day.

Rental items found and in use in your booth are subject to "Standard" pricing.

COMPANY NAME: _____ BOOTH NUMBER: _____

CONTACT NAME: _____

CONTACT EMAIL ADDRESS: _____

Email completed form to: customerservice@shepardes.com



ADDITIONAL ACCESSORIES

International Converting Exhibition and Conference

F126741021

Orange County Convention Center (West Building) | Orlando, FL

October 19 - 21, 2021

ONLINE & DISCOUNT DEADLINE:* MONDAY, SEPTEMBER 20, 2021

If you wish to order any additional accessories for your booth packages, please use the order form below to do so.

Please Note: There will be no substitutions on package components.

Additional Accessories

CODE	QTY	ITEM	DISCOUNT	REGULAR	TOTAL
66053		FLAT SHELF (12" X 39")	\$71.65	\$107.50	
66054		SLANTED SHELF (12" X 39")	\$82.70	\$124.45	
66051		STEM LIGHT (ELECTRICAL NOT INCLUDED)	\$93.70	\$140.60	
66058		(2) TRACK LIGHTS (ELECTRICAL NOT INCLUDED)	\$137.80	\$206.75	

Please see the information about graphics and artwork submissions in the Additional Booth Signage section

For any modifications or changes to the All-Inclusive Booth Packages please contact our Exhibit Solutions Department at exhibits@shepardes.com

TOTAL ESTIMATE	\$ _____
TAX (All tax rates are subject to change)	6.50%
AMOUNT DUE	\$ _____

Submission of this form indicates you read and accept the Payment Policy and Terms & Conditions. All orders cancelled by the exhibitor within 30 days of first day of exhibitor move in day may be subject to cancellation fees up to 100% of the total order, based upon the status of move-in, work performed and/or Shepard set-up costs or expenses. There are no exchanges or refunds once item has been delivered to your booth. Cancellations must be received in writing within 14 days prior to first exhibitor move in day.

Rental items found and in use in your booth are subject to "Standard" pricing.

COMPANY NAME: _____ BOOTH NUMBER: _____

CONTACT NAME: _____

CONTACT EMAIL ADDRESS: _____

Email completed form to: customerservice@shepardes.com

